

	<h1>Product Specification</h1>	Specification Number	A196-10
		Revision	01

Part No. A196-10

Description Stainless Storage Drum 10L with 1" Ferrule

Materials of Construction:

- Body: 316L stainless steel
- Ferrule: 316L stainless steel
- Lid: 316L stainless steel
- Clamp: 304 stainless steel
- Handles: 304 stainless steel
- Gasket: Silicone (FDA 177.2600 and USP Class VI compliant)

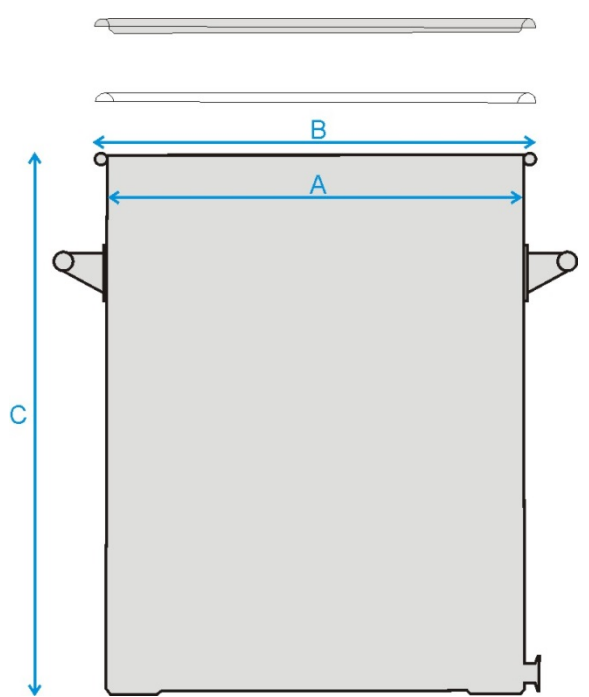

Nominal Volume: 10 Litres

Method of Construction: Welds ground and polished

Surface Finish: Better than 0.5 microns Ra

Dimensions
A = 230 mm
B = 250 mm
C = 270 mm

Graduation Marks: None

Ferrule: 1" (to standard BS4825-3)

Ferrule location: 25mm from base to underside of ferrule

Handles: 2 side handles welded onto patch plates

Weight: 3.65 Kg (body + gasket + lid + clamp)

Specification Approved By:	Signature: 	Name: Jonathan Fenner Position: Director Date: 28-Sep-18
----------------------------	--	--